

THE PROPERTY OF THE DRAWING IS ESTABLISHED BY LAW. IT IS FORBIDDEN TO PRODUCE OR SHOW IT TO THIRD PARTY, WITHOUT A WRITTEN AGREEMENT.

Item	Name	Q. ty
1	CA.08.14.014	1
2	WLS.18.18	1

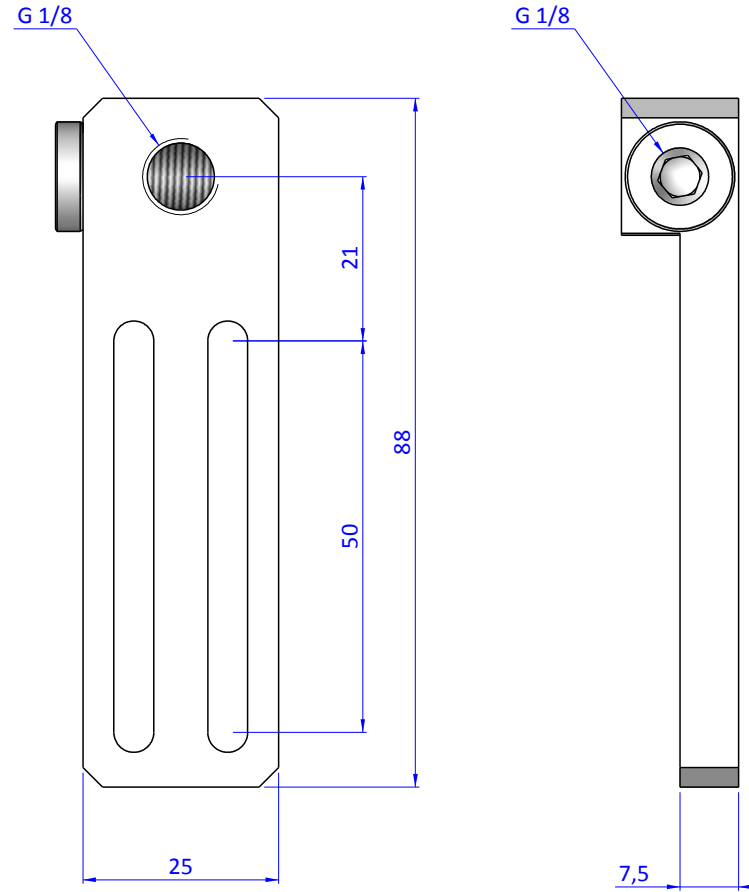
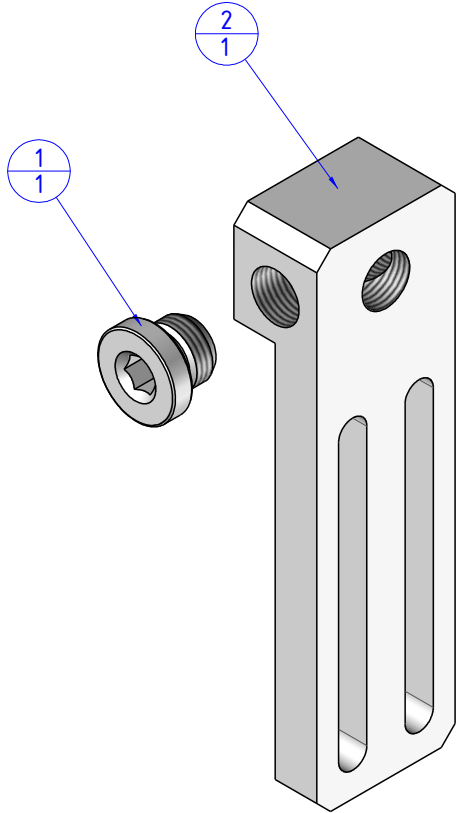

Format A3

UNI 936-76

FP SERVICES AUTOMATION		DESIGNED FROM FPSERVICES		REVIEW A
GENERAL TOLERANCE UNI - ISO 2768 CLASSE f		DATE 27/02/2019	WEIGHT 0,044kg	
DESCRIPTION CA.WLS.18.18		CODE CA.WLS.18.18		